

Varenummer: 203180M16100B3U

Beskrivelse: E+G Justerfod
GN 31-80-M16-100-B3-U

Note: U Uden møtrik, sekskant i toppen, spændeflade i bunden

Mål

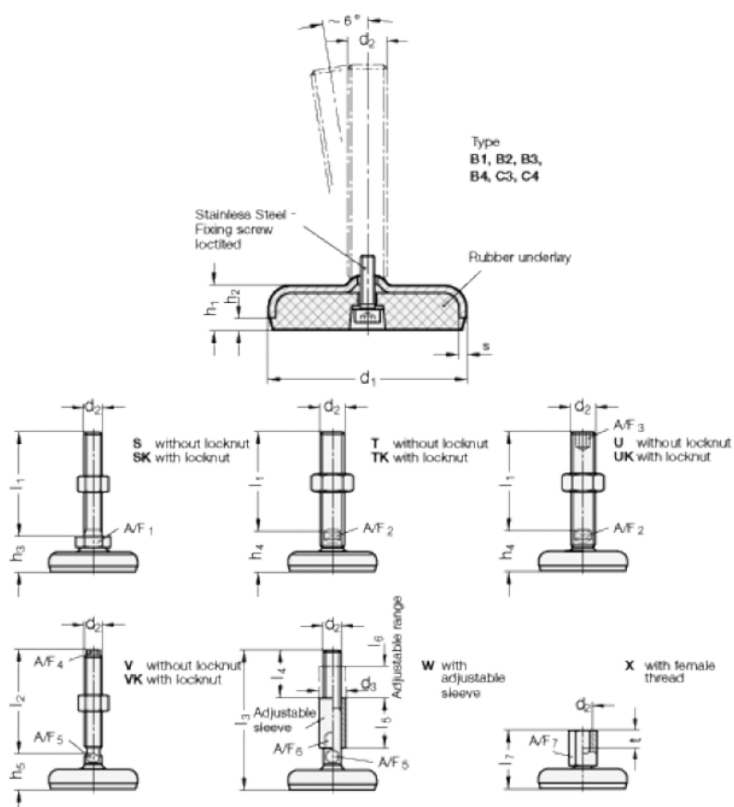

A/F2	= 12	s = 3
A/F3	= 8	
d1	= 80	
d2	= 16	
h1	= 18	
h2	= 5	
h4 +4.0/0	= 32	
l1	= 100	